

Fixtures & Fittings



Cup hinge



Butt hinge



t hinge

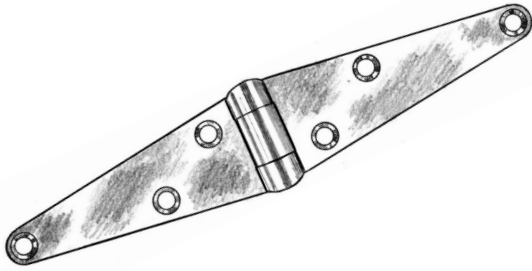

Strap hinge

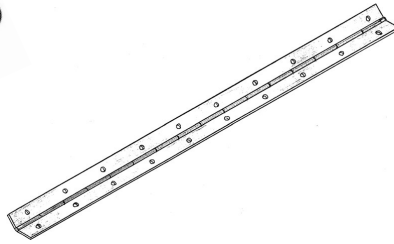

Piano hinge

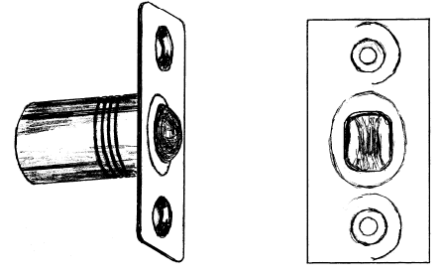

Ball catch

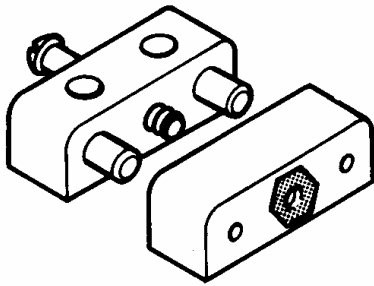

Knock down block

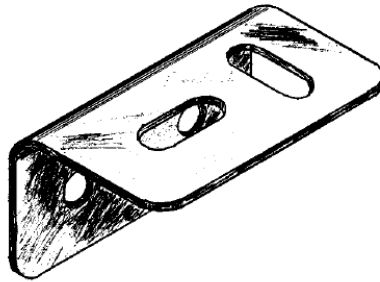

L bracket



Round wire nail

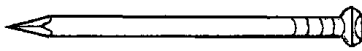

Oval wire nail

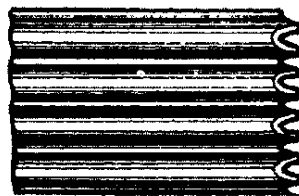

Corrugated fastener

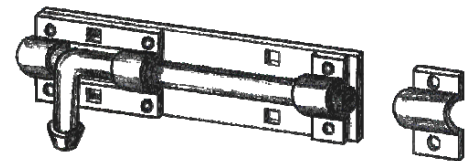

Barrel bolt

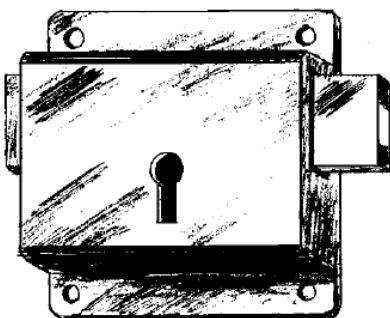

Dead lock

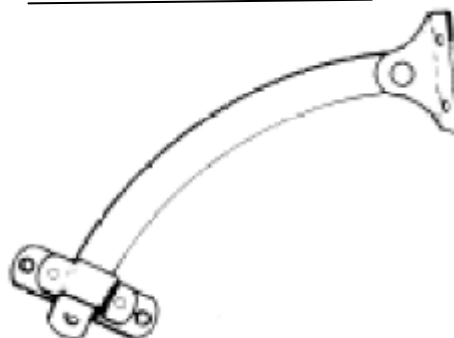

Stay flap

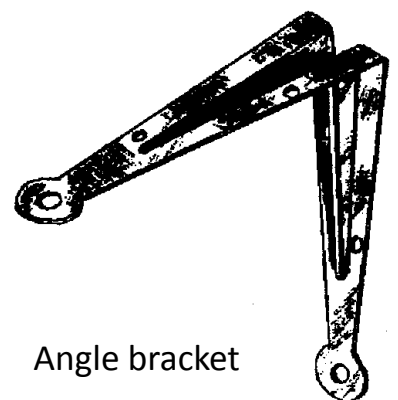

Angle bracket

Power Tools



Router



Orbital sander



jigsaw



Biscuit joiner



Electric drill



Cordless drill



Orbital sander

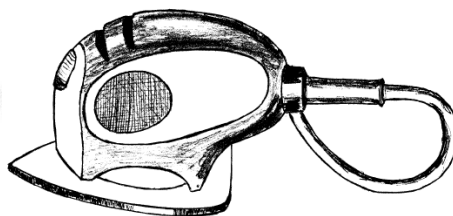

Palm sander

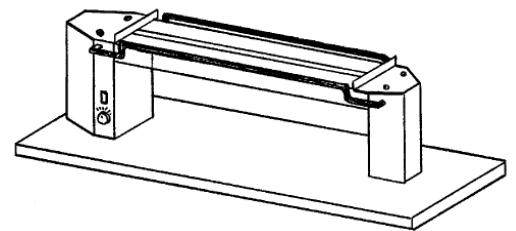

Strip heater

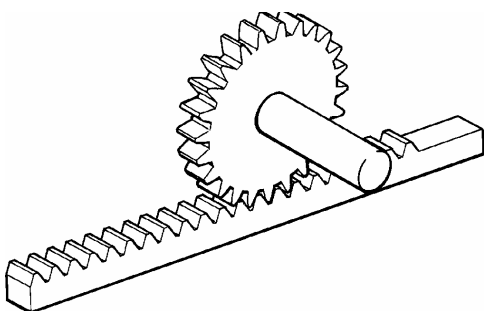

Gear rack

Hand Tools



Pincers



Sash cramp



Nail punch



Block plane



Marking gauge

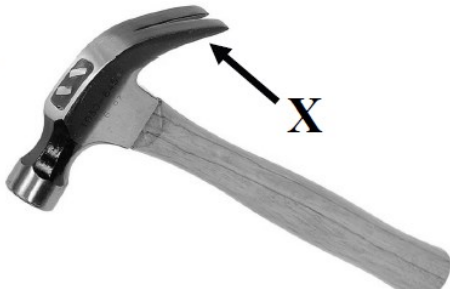

Claw hammer



Thin nose pliers



scriber



gouge

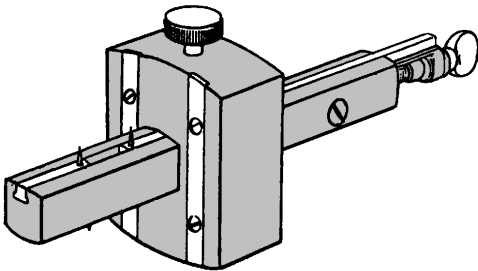

Mortise gauge

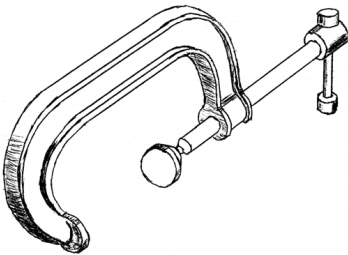

G clamp

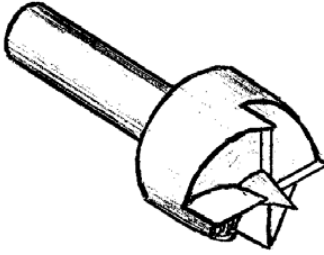

Drive centre

Hand Tools

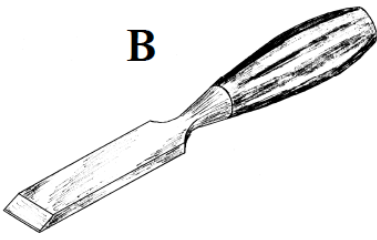

Firmer Chisel

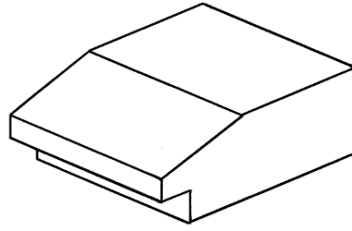

Thumb gauge

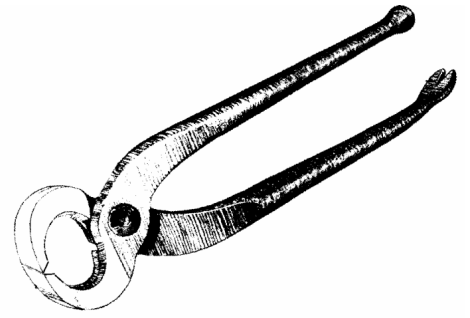

Pincers

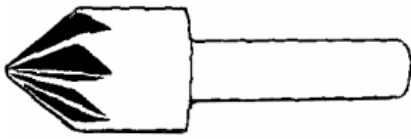

Countersink bit

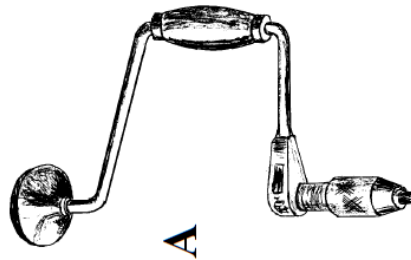

Carpenters brace

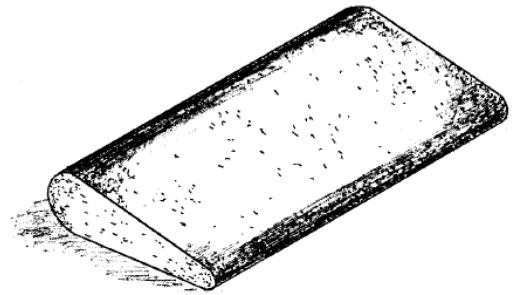

Slip stone

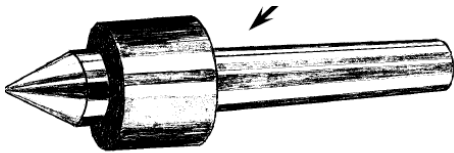

Live centre

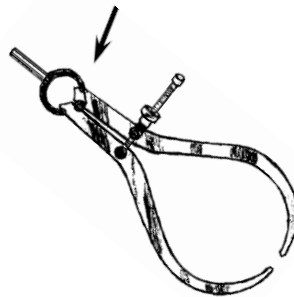

Outside callipers

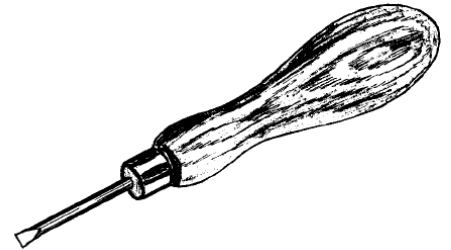

Bradawl

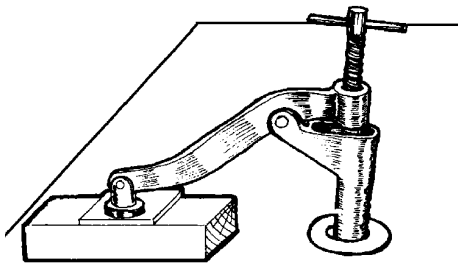

Bench holdfast

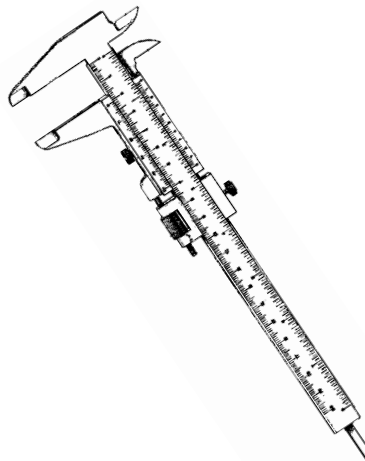

Vernier callipers

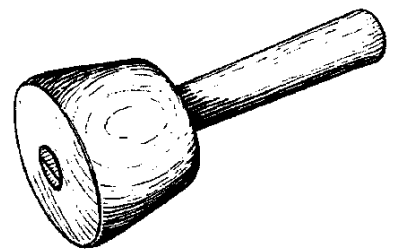

Carvers mallet

Hand Tools

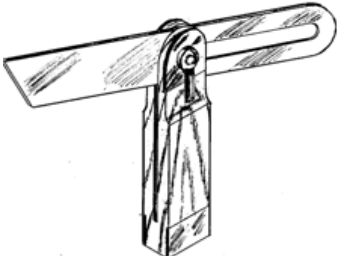

Sliding bevel

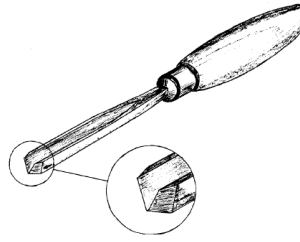

V tool

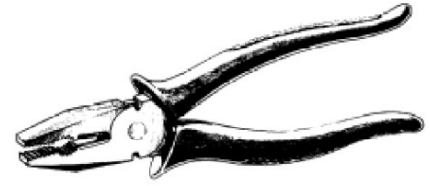

pliers



Hole saw

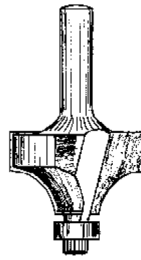

Router bit



spokeshave



snips

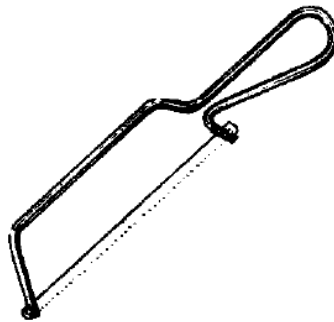

Junior hacksaw



Warrington hammer



surform



Dovetail saw



Vice grips